

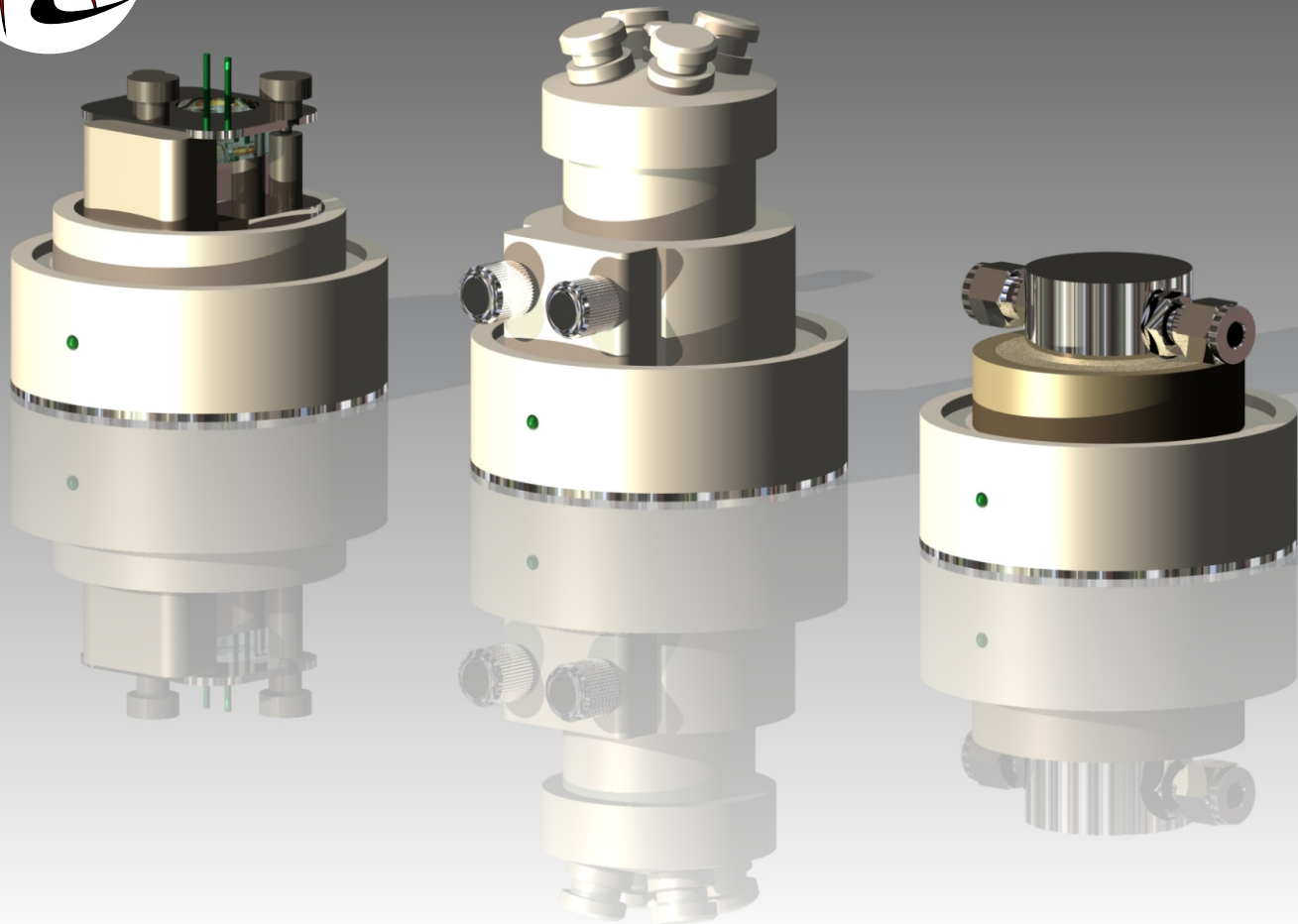

EUREKA ORDERING INFORMATIONS

EUREKA - YOUR BEST NANOGRAVIMETRIC SOLUTION



Eureka is the first nanogravimetric scientific instrument (QCM and EQCM) in the world that is powered only by the PC USB port, it is an innovative device extremely compact, light and reliable, designed according to the new frontiers of microelectronics. Moreover only Eureka is able to work with every value of input frequency, ranging from 1Hz to more than 50MHz, this means that you can use any quartz crystals as transducer, and at higher frequencies you can obtain extremely good resolutions in the picograms range. It is possible to choose the instrument Eureka with different measurement speeds, starting with the cheaper version, one frequency measure per second, till the more sophisticated version with four frequency measurements per second. The software supplied with Eureka, running under Microsoft Windows™, is extremely powerful, user-friendly and easy to use, for this reason you will spend only 5 minutes to learn it, then

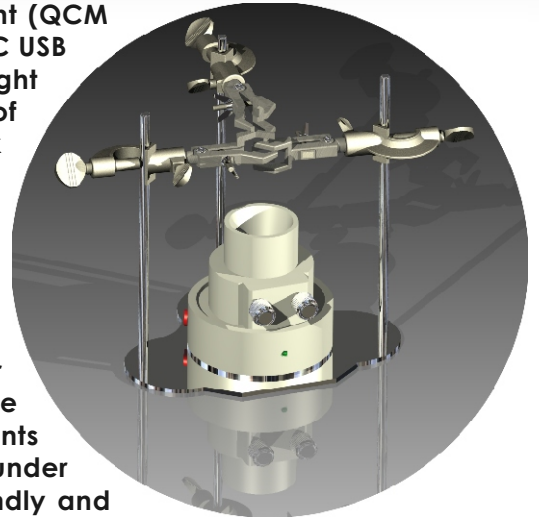

you will perform your first experiment immediately, moreover the acquired data can be saved in an Excel compatible format while the plot charts can be saved as Bitmap images. BioAge provides static and flow-through measurement chambers for liquids and gases, in this way you can use Eureka to perform a wide range of experiments. To have more technical data with electrical and mechanical specifications you can read the Eureka Brochure document.

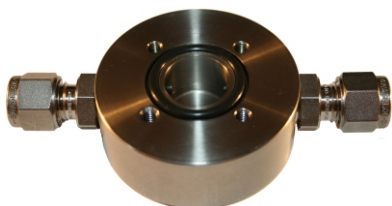

All our standard equipments is realized with the best materials like Teflon and AISI316 Stainless Steel

CUSTOM SOLUTIONS

BioAge develops static and flow-through custom measurement chambers for gases and liquids according to your particular technical specifications, please contact us for your custom solution.

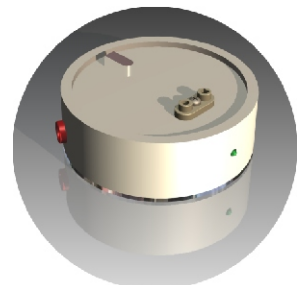

CODE
010868-22

4 MEAS/SEC - EUREKA COMPLETE STANDARD SYSTEM

CODE
010868-21

2 MEAS/SEC - EUREKA COMPLETE STANDARD SYSTEM

CODE
010868-20

1 MEAS/SEC - EUREKA COMPLETE STANDARD SYSTEM

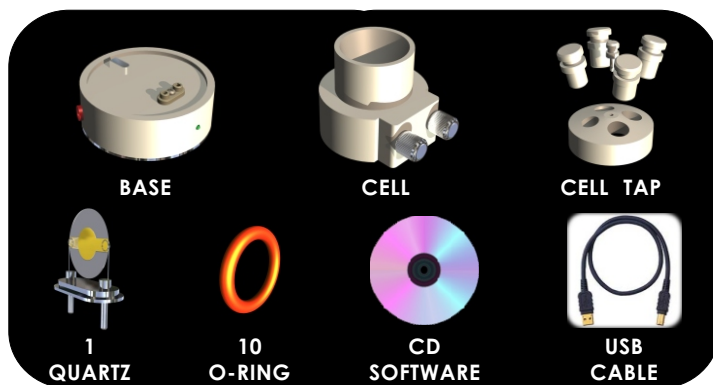

This full Eureka standard system, provided inside a black smart carrying case, is composed by the Eureka measurement chamber static for liquids, and by all the other components shown in the upper image, with this system you can carry out any QCM and EQCM experiments, others chambers for liquids and gases are available as optionals.

CODE
010868-01

ELECTRODES HOLDER BASE



This hard-wearing AISI316 Stainless Steel base is very useful in to carry out an EQCM experiment, holding the potentiostat electrodes and the other accessories to be dipped into the static cell. This device has been designed to work with the electrode holder clamps code 010868-02.

CODE
010868-02

ELECTRODE HOLDER CLAMP



They are been purposely chosen, during the design, to work with the electrode holder base code 010868-01, they allow to bring electrodes, and others useful accessories during an EQCM experiment. Thanks to three regulation screws and a rotation axis it is possible to regulate the better work position of all the electrodes and the others accessories.

CODE
010868-03

CUSTOM STATIC CHAMBER TAP



The Eureka standard chamber is supplied with a tap with holes suitable for the most common electrodes, but if you need to work with other electrodes and accessories with different diameters you can order this custom tap specifying the numbers of the holes and their diameters.

CODE
010868-04

O-RING SEAL



These silicone O-Ring seals are suitable to be used with all the Eureka chambers. It is advised to buy several O-Rings to be used as spare parts when you work with aggressive liquids and solutions.

CODE
010868-05

QUARTZ CRYSTAL 10MHz Ø14mm - POLISHED

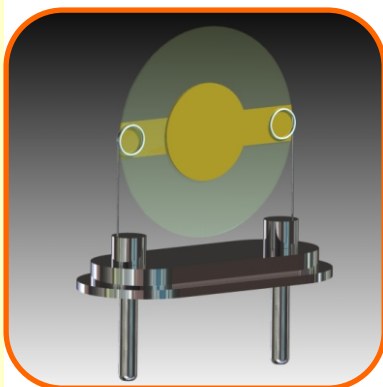

This high quality 10MHz polished quartz crystal has gold plated electrodes and it is installed on a socket suitable to be used with all the Eureka chambers for liquids. It is possible to make measurements in gaseous phase installing only this quartz in the Eureka oscillator base or using a suitable chamber for gas.

CODE
010868-07

QUARTZ CRYSTAL 20MHz Ø8mm

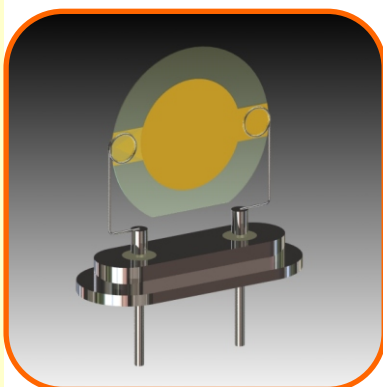

This high quality 20MHz quartz crystal has gold plated electrodes and is installed on a socket suitable to be used with all the Eureka standard chambers for gases.

CODE
010868-08

QUARTZ CRYSTAL 20MHz Ø8mm - POLISHED

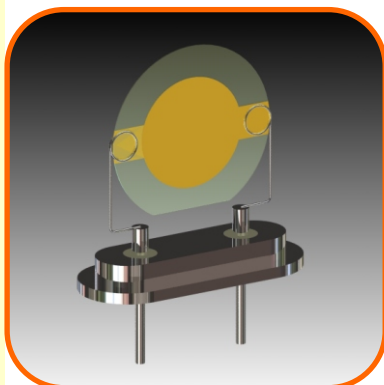

This high quality 20MHz polished quartz crystal has gold plated electrodes and is installed on a socket suitable to be used with all the Eureka standard chambers for gases, the quartz surfaces are polished.

CODE
010868-10

FLOW-THROUGH CHAMBER FOR GASES

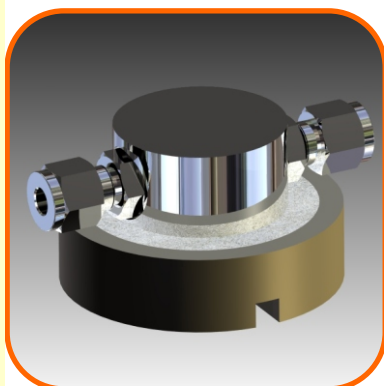

This is a flow-through measurement chamber for gases, the chamber is made of AISI316 Stainless Steel, the inlet and outlet connectors are 1/4" Swagelok™, it works with the quartz crystal at 20MHz code 010868-07 or 010868-08.

CODE
010868-11

FLOW-THROUGH CHAMBER FOR LIQUIDS

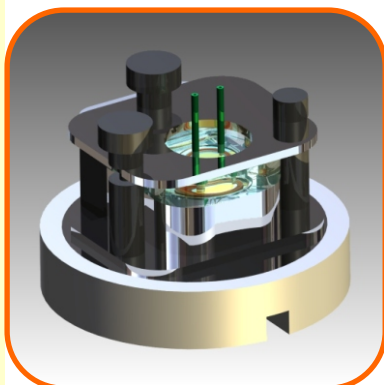

This is a flow-through measure chamber for liquids, the upper part of the chamber is optically transparent, two suitable pipes allow the input and the output of the liquid, it works with the quartz crystal at 10MHz code 010868-05.

Acceptance of any order is subject to our terms and conditions. Any deliveries quoted are subject to the exigencies of Customs and carrier services for which we cannot be held responsible. Prices are subject to the rate of VAT applicable at the date of invoice. Only Italian law will apply. According to the spirit of a continuous research and innovation, and in the interest of a continuous products development, BIOAGE s.r.l. reserves the right to make improvements on the products here described at any time, without notice or obligations.

ADDRESS: BIOAGE s.r.l.
Via Trento, 77
88046 Lamezia Terme
(CZ) ITALY

WEBSITE:
www.bioage-srl.com

TEL: (+39) 0968 51061
MOBILE: (+39) 349 3564443

EMAIL:
info@bioage-srl.com
research@bioage-srl.com
quotation@bioage-srl.com